



**USER'S MANUAL**

**WHEEL BALANCER**

**INVENTO VB 470**





## DECLARATION OF CONFORMITY

Complies with EN ISO/IEC 17050-1 and EN ISO/IEC 17050-2

, located in ,

Manufacturer of the range of wheel balancers model

Serial Number \_\_\_\_\_

Declare under our own responsibility that the product to which this declaration relates, is in conformity with the followings directives:

- **Directive 2006/42/EC (Machinery Directive, MD)**
- **Directive 2004/108/EC (Electromagnetic Compatibility Directive, EMC)**

The followings standards have been applied:

- **EN 60204-1:2006 + A1:2009**
- **EN ISO 11202:2010**
- **EN ISO 12100:2010**
- **EN ISO 13850:2012**
- **EN ISO 13857:2008**

The technical file of the above mentioned machines is guarded by the manufacturer:

, located in

### IMPORTANT:



Any changes to the machine, ignoring the instructions contained in the user manual or use of the machine other than that provided by the manufacturer, will invalidate this declaration.

## INDEX

1.	Preface	Pag. 2
2.	Safety regulations	Pag. 3
3.	Carriage, hoisting, storage and transportation of the machine	Pag. 3
4.	Installation and switching on	Pag. 5
5.	Installation	Pag. 6
6.	Suspension of the use	Pag. 6
7.	Environmental information	Pag. 6
8.	Technical data	Pag. 7
9.	Routine maintenance of the wheel balancer	Pag. 8
10.	Monitor	Pag. 9
11.	Keyboard	Pag. 10
12.	Operating modes standard, service, stand by	Pag. 10
13.	Machine calibration	Pag. 11
14.	Use of the machine in NORMAL MODE	Pag. 16
15.	Optimization	Pag. 26
16.	Hidden weights program	Pag. 28
17.	Second operator	Pag. 30
18.	Utility programs	Pag. 31
19.	Error codes	Pag. 39
20.	Fire prevention means to use	Pag. 40
21.	Additional note	Page.41

## 1. PREFACE

Confirming the machine including the operation system, tools and accessories are operated normally and without any damage, you hand the machine to the customers and the machine will endue some period of guarantee. During this period, the manufacturer will repair the machine or the no-normal parts of the machine or machine itself free of charge but will not be responsible for the damage and wear and tear caused by the no-normal usage, transportation and maintenance. And the manufacturer will not notify the customers when he renews the products or improves the production line. The purpose of this manual is to provide the users and owners of this machine with the guide of safety and regulation to make the operators properly maintenance and operates the machine. If you carefully follow this instruction manual, the machine will provide you with the service of higher efficiency and more durable. The following paragraphs will provide you with the danger level related to the machine.

	Danger: operation can cause the serious injury or death.
	Warning: operation can cause the serious damage or unsafe.
	Caution: operation can cause slight wound and the damage of the objects.

\*Read the manual carefully before use the machine and keep this manual on the document folder near the machine for check at any time.

\* Technical document should be considered to be the integrated part of the machine and it should be placed together with the machine when being sold to the new owner.

\*Only when the series number and model of the manual are same to the series number and model on the nameplate, the manual can be considered to be effective.

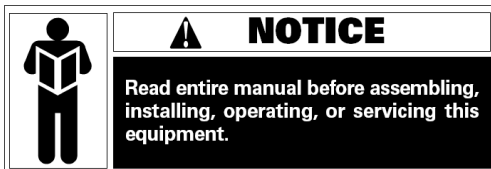

\* Firmly keep in mind and follow the description and information of this manual at any time and the operators should be responsible for the operations not described and authorized in the manual.

\* Some information of the manual comes from the pictures, it is normal that you will see some differences to the standard machines.

\* Do not try the other operations except under the guidance of the personnel with experience. If necessary, please contact with the authorized service center for help.



The select of the installation site must be in accordance with the current effective safety regulation. We should specially point out that the installation and operation of the machine must have the anti-moisture protective methods. If you want to correctly and safely use the machine, you should meet the following environment requirements:

- Luminosity in site should be at least 300 lux.
- RD : <85% (without condensation).
- Environment temperature: 0° -50°C.
- The floor of the ground should be enough solid to support the maximum weight of the machine.
- The machine should not be used in the environment with the potential exploded factors.

## 2. SAFETY REGULATIONS



\* Not following the information and overlooking the warning labels will cause the series injuries to the operators and the other personnel.

\* You can operate the machines after you completely read and understand the entire damages/warnings.

\* The correct use of the machine needs the professional operator who must undertake the suitable training and can understand the written descriptions of the manufacturer, familiar with the safety regulations and follow all these descriptions and regulations. And mean while the operator should be a person without bad habit and of healthy of mentality and physiology.

Before operating the machine, you must have the following conditions:

- Read and understand the information and the description in the manual
- Fully understand the characteristic and the features of the machine
- Keep the unauthorized personnel from the operative site
- Be sure the installation should be in accordance with the current standard and the regulation
- Be sure that the operators of the machine should induce the proper training and operate the machine correctly and safety.
- Before power off the machine, do not touch the cables, motors or other electrical elements.



Do not remove or wear out any label of danger, caution and warning or instruction. If the label is lost or fuzzy, you should change it at once. If the label is missing, please contact with the nearest dealer to get it.

- See the accident precaution regulation related to the operation and maintenance of the mechanism of high voltage and rotation
- The manufacturer will not be responsible for the damage and accident caused by the changes and modifications not authorized by the manufacturer.

### **3. CARRIAGE, HOISTING, STORAGE AND TRANSPORTATION OF THE MACHINE**

Place, transport and store the machine according to the indication on the package container. When transport and hoist the wheel balancer, do not make the accessory hang, weight tray, balance shaft and display cover to be the weight bearing area because this can cause the damage of the machine or the precision error and even the injury to the operator. According to the construction of the wheel balancer, the center of gravity is on the right off-center, therefore when lift the machine unpacked, the lift arm of the hydraulic vertical lift of the forklift should be deflect to the right meaning not exceed 1/4 of the width of the machine. It is best to cover a layer of paper shell and rubber to avoid the slide of the machine. When lift and slide the machine, there should be the personnel to hold the machine and the maximum height of lifting should not exceed one meter. If exceeding one meter, you should fix the machine properly.

If hoist the wheel balancer, you can pass the wide cloth band through the clearance under the machine. The cloth band must be 2 pieces or more than 2pieces and the load bearing should be more than 500kg and the length should be of same. The position of the cloth band should be in accordance with the requirement of lifting the machine. When hoist, it is best that some personnel to hold the machine. When lift or hoist the machine, the speed should be not more than 35mm/s for fear that the much inertia causing the slide and swing of the machine to cause the dangerous.

**Storage:** The machine should not be exposed and should be covered with the plastic film. The machine should be stored in the warehouse of ventilation, dry and waterproof. In the storage area, the temperature should be controlled in the range of -10°C~55°C and RH should be controlled in the range of 30%~90%. It is forbidden to store the machine together with the dangerous chemical, the inflammable and explosive materials or the objects easy to born the dust.

**Transportation :** The load of the machine should be accordance with the indication on the outer package and fix firmly. No matter what kind of transportation, the environment temperature and humidity should comply with the requirement of the storage

requirement specified in term2.2. It is forbidden transport the machine together with the dangerous chemicals, inflammable and explosive materials or the objects easy to born the dust.

### Installation

After confirming the package of the wheel balancer intact, you can carry the machine to the installation area as shown in the Fig1 Environment requirement at the installation site: Temperature 0°C-50°C, RH≤85%, without water source, fire source, dust, inflammable and explosive materials and the chemicals. The floor should be flat and solid.

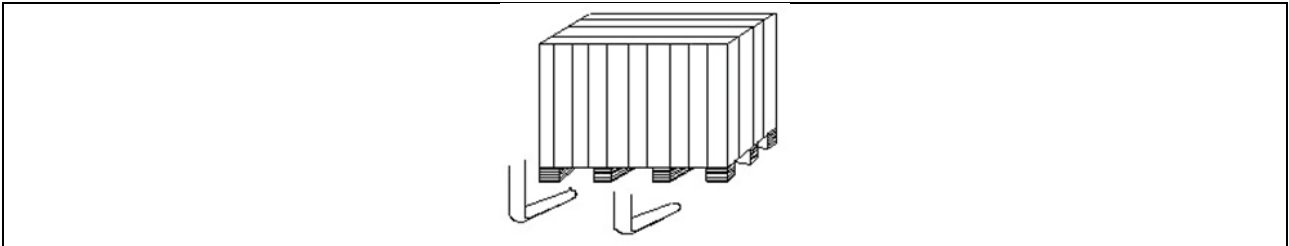

Before installation, detach the upper cover of the package box of the wheel balancer and confirm the machines, accessories shipped together with the machine and the data you purchase according to the packing list. If you have any question, you can contact with the dealers. The packing material such as plastic, polystyrene, nail, screw, wood and the carton must be placed into a scrap box and handle according to the local law and regulation. When install, detach the connect bolt between the wheel balancer and the pallet of the package box and move the machine from the pallet to the installation position. To guarantee the safety and fast of the operation, there should be the distance more than 300cm from the wall of the building to the right and rear of the machine. And the distance of more than 200cm from the wall of the building to the left of the machine. After the wheel balancer is moved to the proper position, drill 3 anchor holes on the ground according to the installation hole at the foot of the machine and then use 3 pieces of M10X160 anchor screws to fix the machine on the ground to guarantee the stability and reliability of the machine.

If the machine is not packed, observe following precautions:



**PROTECT THE SHARP EDGES AT THE ENDS WITH SUITABLE MATERIAL (Bubble wrap or cardboard).**



**DO NOT USE METAL WIRE ROPES FOR LIFTING BOARD.**



**SLING WITH STRAPS OF AT LEAST 200 cm IN LENGHT AND WITH A HIGHER FLOW RATE OF 500 kg.**



**DO NOT FORCE ON SHAFT AND/OR FLANGE.**



**ALWAYS UNPLUG THE POWER SUPPLY CABLE FROM THE SOCKET BEFORE MOVING THE MACHINE.**

### 4. INSTALLATION AND SWITCHING ON

After unpacking wheel balancer, check the status of integrity and presence of faults, make the assembly of the component sas shown in following pictures.

#### 4.1 Electrical connection

The standard version of the machine must be connected to a mains 230V Single Phase.

The change of the power supply cannot be realized by the user; it must be requested to BRIGHT or to a dealer or to an authorized service center. To accomplish the electric connection, connect the machine's power supply cable with the plug in use in the country.



**ALL OPERATIONS TO MAKE ELECTRICAL CONNECTION AND INTERVENTIONS (HOWEVER LIGHT) ON ELECTRICAL PARTS MUST BE CARRIED OUT BY QUALIFIED PERSONNEL.**

The dimensioning of electrical connection must be carried out in according to electric power absorbed by the machine. The absorption is specified in paragraph 10. The user must:

- Check that the supply voltage correspond to the voltage indicate on the nameplate of the machine;
- Check the conditions of the wire and the presence of the ground conductor;
- Check the machine is connected to its own electrical connection, fitted with a proper 30 mA sensitive automatic circuit breaker, against a possible electrical overload over 30 mA;
- Connect the power supply cable to the plug with great care and following to the current regulations.



**WHEN THE MACHINE IS TURNED OFF FOR A LONG TIME IT IS NECESSARY TO DISCONNECT THE POWER PLUG TO AVOID USE BY UNAUTHORIZED PERSONNEL.**



**IF THE MACHINE IS CONNECTED DIRECTLY TO THE POWER SUPPLY BY MEANS OF THE MAIN ELECTRICAL BOARD AND WITHOUT THE USE OF A PLUG, INSTALL A KEY-OPERATED SWITCH TO RESCTRICT THE MACHINE USE EXCLUSIVELY TO QUALIFIED PERSONNEL.**



**IN CASE OF OPERATIONS ON ELECTRIC PARTS, CABLES ENGINES OR ANY ELECTRIC DEVICES, IT IS NECESSARY TO CUT OFF THE ELECTRICITY.**



**DO NOT REMOVE, DAMAGE AND MAKE COMPLETELY ILLEGIBLE THE STICKERS OF DANGER, WARNING, INSTRUCTIONS AND CAUTION. REPLACE ANY MISSING, DAMAGED OR ILLEGIBLE STICKERS. THE STICKERS CAN BE FOUND AT THE NEAREST DEALER OF MANUFACTURER.**



**THE DAMAGE FOR FAILURE TO COMPLY WITH THE ABOVE WRITTEN INSTRUCTIONS, IT WOULD BE NOT CHARGED AGAINST THE MANUFACTURER AND IT MAY CAUSE THE INVALIDATION OF THE WARRANTY.**

## 5. INSTALLATION

### 5.1 Installation area

To install the machine you need a useful space on the basis of the information given in picture F5.1.



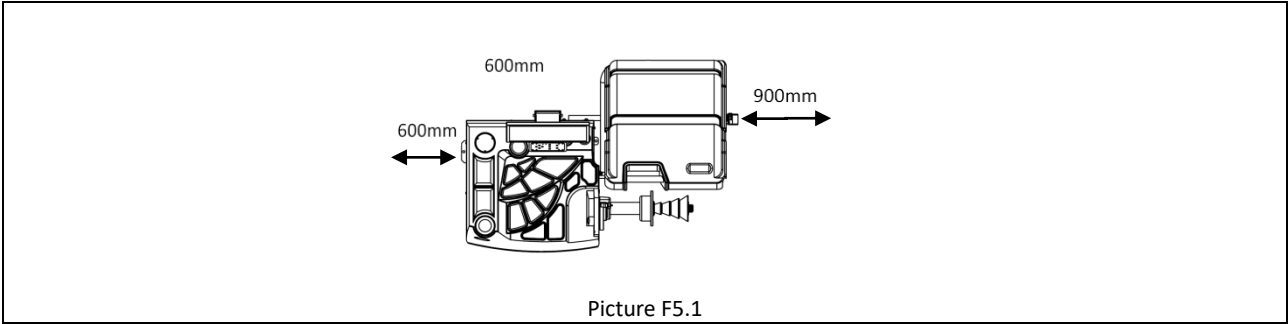

From working position, the user must be able to view the machine and the surrounding area.



**INSTALLATION AREA MUST BE KEEP CLEAR BY POSSIBLE DANGEROUS OBJECTS.**



**UNAUTHORIZED PERSONNEL MUST NOT STAND NEAR BY THE WORKING AND INSTALLATION AREAS.**



**THE MACHINE MUST BE PLACED ON A HORIZONTAL SURFACE RATHER MADE OF CONCRETE OR TILED.**



**AVOID BREAKABLE AND ROUGH SURFACES.**



**SURFACE MUST ENDURE THE STRESS LOAD DURING THE MACHINE OPERATION.**



**THE MACHINE MUST BE FIXED ON THE FLOOR WITH SCREWS AND EXPANSION PLUGS IN ACCORDING TO FOLLOWING INSTRUCTIONS.**



**THE USE OF THE MACHINE IS ONLY ALLOWED IN PLACES THAT DO NOT PRESENT RISKS OF EXPLOSION OR FIRE.**

**6. SUSPENSION OF THE USE**

In case the machine is not used for a long time it is necessary to disconnect the power supply and protect all parts that could be damaged by dust. Grease all parts that could be damaged in case of oxidation. In this specific case, protect the shaft and flange.

**7. ENVIRONMENTAL INFORMATION**



**THE DISPOSAL PROCEDURE DESCRIBED BELOW ONLY APPLIES TO MACHINES WITH THE SYMBOL OF THE WASTE BIN WITH A BAR ACROSS IT ON THEIR DATA PLATES.**



The crossed-out bin symbol, placed on the product and on this page, reminds the user that the product must be disposed of properly at the end of its life. This product may contain substances that can be hazardous to the environment and to human health if it is not disposed of properly. We are therefore providing you with the information below in order to prevent these substances from being released into the environment and to improve the use of natural resources.

Electrical and electronic equipment must never be disposed of in the usual municipal waste but must be separately collected for their proper treatment.

Thus, the hazardous consequences that non-specific treatments of the substances contained in these products, or improper use of parts of them, may have on the environment or on human health are prevented. Furthermore, this helps to recover, recycle and reuse many of the materials contained in these products. Electrical and electronic manufacturers and distributors set up proper collection and treatment systems for these products for this purpose. At the end of the product’s working life contact your supplier

for information about disposal procedures. When you purchase this product, your supplier will also inform you that you may return another worn-out appliance to him free of charge, provided it is of the same type and has provided the same functions as the product just purchased.

Any disposal of the product performed in a different way from that described above will be liable to the penalties provided for by the nation regulations in force in the country where the product is disposed of.

Further measures for environmental protection are recommended: recycling of any packaging of the product and proper disposal for used batteries (only if contained in the product).

## 8. TECHNICAL DATA

### General features

Power supply voltage(1)	100/230 V
Power consumption	90 W
Balancing speed	140 rpm
Maximum unbalance calculated	200 gr.
Accuracy	± 1 gr.
Shaft diameter	40 mm
Working environment temperature	0° -- + 50° C
Storage temperature	-10° -- + 50° C
Storage relative humidity	30% -- 80%
Machine weight (without accessories)	149 Kg.
Noise level	<70 dB(A)

(1) The voltage supply must be specify at the order. It is not possible to connect a machine with supply voltage of 230 V to a mains of 110 V and vice versa.

## 9. ROUTINE MAINTENANCE OF THE WHEEL BALANCER



Warning

The manufacturer declines all responsibility in the event of claims resulting from the use of non-original spare parts or accessories.



Warning

Unplug the machine from the socket and make sure that all moving parts have been locked before performing any adjustment or maintenance operation.



Warning

Do not remove or modify any part of the machine (except for service interventions).



Caution

Keep the work area clean.

Never use compressed air and/or jets of water to remove dirt or residues from the machine. Take all possible measures to prevent dust from building up or rising during cleaning operations. Keep the wheel balancer shaft, the securing ring nut, the centering cones and flange clean. These components can be cleaned using a brush previously dipped in environmentally friendly solvents. Handle cones and flanges carefully so as to avoid accidental dropping and subsequent damage that would affect centring accuracy. After use, store cones and flanges in a place where they are suitably protected from dust and dirt. If necessary, use ethyl alcohol to clean the display panel. Perform the calibration procedure at least once every six months.

## 10. MONITOR

The machine's control monitor is illustrated in figure F10.1. The control monitor is used by the operator to view the applied controls and the data entered with the keyboard. The same control panel displays the balancing results and machine messages. The control key functions are described in table T10.1.

Picture F10.1: Monitor

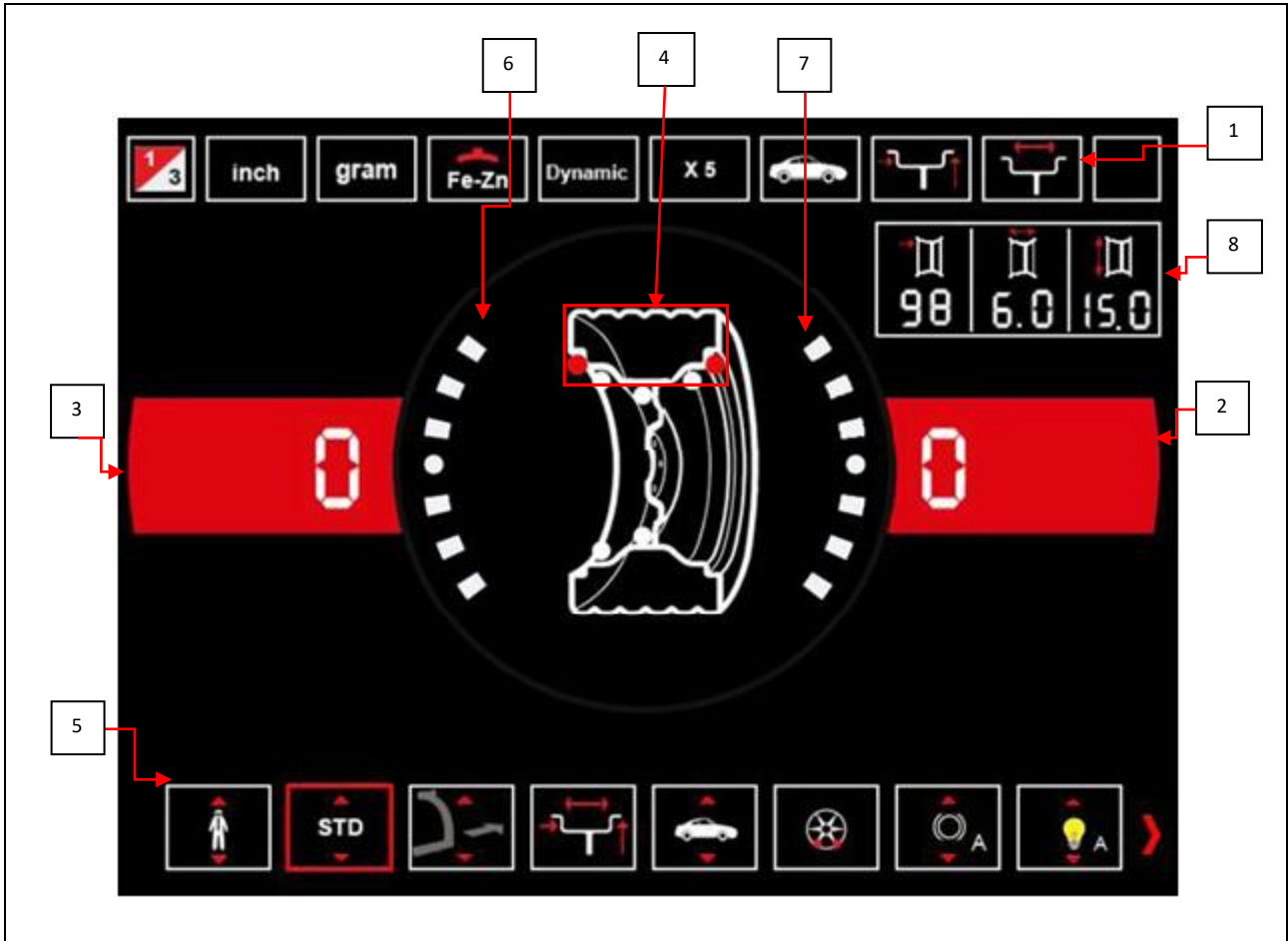

Table T10.1: Functions of different parts of the control monitor

Pos.	Description
1	Status icon band.
2 – 3	Display shows unbalance value inside – outside.
4	Imbalance Position indicator. Position depends by the Program and Wheel Type selected.
5	Control icon band.
6 – 7	Indicator shows angular unbalance position inner - outer.
8	Wheel dimensions data band.

## 11. KEYBOARD

In this manual, the keys are numbered for convenience from [1] to [9] as shown in picture F11.1. The nine keys have only one primary function.

Picture F11.1: Keyboard



Table T11.1: Functions of the keys

Pos.	Description
1 – 2 – 3 - 4	Function selection keys.
5	“Back” key to go back to the previous view.
6	“Enter” key to confirm selection.
7	Quick menu( control illuminator)
8	“Start” key to start the motor.
9	“Stop” key to stop the motor.
	STAND BY led
	Machine status led.

## 12. OPERATING MODES STANDARD, SERVICE, STAND-BY

The machine features three operating modes:

- STANDARD mode. This mode is enabled after the machine is turned on and it is possible to perform the wheels balancing;
- SERVICE mode. In this mode various utility programs are available for setting parameters (such as grams or ounces) or checking the machine operations (such calibration);
- STAND-BY mode. After 5 minutes without user activity, the machine automatically switch to STAND-BY mode to reduce electrical consumption (both with wheel guard raised or lowered). The STAND-BY green led on the control panel is blinking it means the machine is in this operating mode. All acquired data and settings are held in STAND-BY mode. In the SERVICE mode is not possible to switch to STAND-BY mode.

To exit from STAND-BY mode choose by any of the following means:

- Press any keys;
- Turn manually the wheel;
- Pull out the distance/diameter sensor from idle position (only for the models with automatic acquisition of distance/diameter);
- Pull out the external sensor from idle position (only for the models with automatic acquisition of width.

*Note: the machine exits the STAND-BY mode also by pressing the key [8] Start or lowering the wheel guard. In these cases simultaneously will be start also the spinning (if you press [8] Start the spin will start only if the wheel guard is already lowered).*

## 13. MACHINE CALIBRATION

To function properly, the machine must be calibrated. Calibration allows storing the mechanical and electrical parameters specific to each machine so provide the best balancing results.





### 13.1 Machine calibration for the CAR/SUV Wheel Type





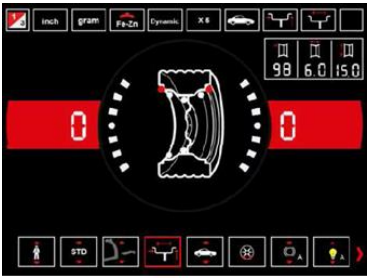

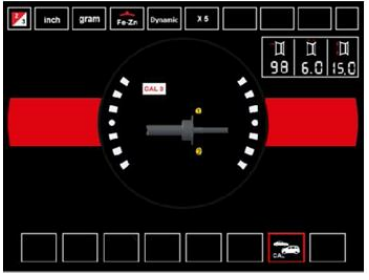

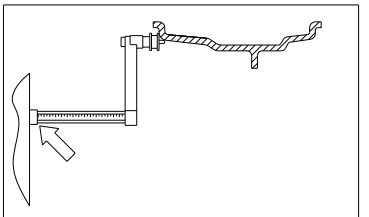

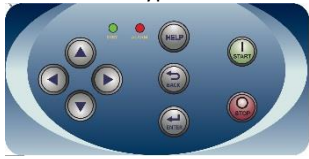

The calibration for the CAR wheel type and SUV wheel type is the same.

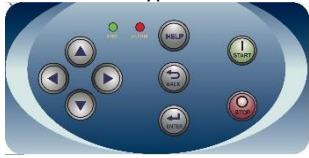



To perform machine calibration, you must first provide for the following material:

- A balanced wheel with steel rim that has the following dimensions: diameter from 14" -----16".  
It is not possible to use wheels with aluminum rims.
- A 50 grams weight (preferably in Iron or Zinc).

To perform the calibration machine, proceed as follows:

Op.	Description	
10	 <p>Press [2] or [4] from the keyboard and select the icon relative to the programme to be used.</p>	
20	 <p>Activate the AUTO/SUV calibration programme by selecting CAL which will turn green.</p>	
30	<p>Confirm activation of the AUTO/SUV calibration programme by pressing [6] on the keyboard.</p>	
40	<p><b>Remove the wheel and any other accessories from the shaft.</b></p>	
50	<p>Lower the wheel guard: the machine will run a launch.</p>	
60	<p>Fit the wheel on the shaft.</p> <p><b>Manually enter the wheel dimensions.</b></p> <p>If the dimensions of the wheel were introduced before entering the calibration program, this step can be skipped. <b>It is not possible to enter the data with the automatic acquisition system.</b></p>	
70	<p>Extract the distance sensor and place it on the wheel as shown here.</p> <p>Read the distance value on the graduated scale. The distance value is always expressed in millimetres.</p>	

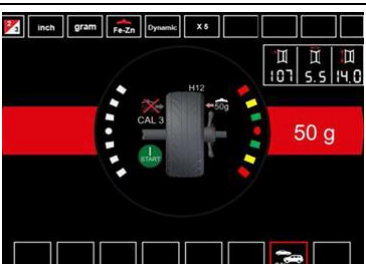
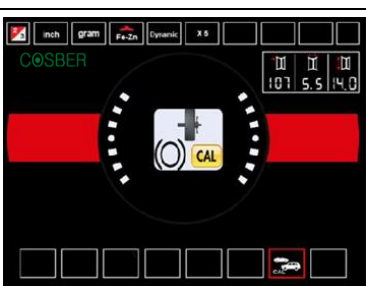
80	<p>Select which type of dimension to enter by pressing [2] or [4] on the keyboard</p>  <p>and activate the wheel - machine distance insertion function by selecting  which will turn green.</p>	
90	<p>Enter the reading by pressing [1] or [3] on the keyboard</p> 	
100	<p>Measure the width of the wheel with the special gauge or read the value of the width indicated on the rim. The value of the width can be in inches or millimetres according to the selected unit of measure.</p>	
110	<p>Select which type of dimension to enter by pressing [2] or [4] on the keyboard</p>  <p>and activate the wheel width insertion function by selecting  which will turn green.</p>	
120	<p>Enter the reading by pressing [1] or [3] on the keyboard</p> 	
130	<p>Select which type of dimension to enter by pressing [2] or [4] on the keyboard</p>  <p>and activate the wheel diameter insertion function by selecting  which will turn green.</p>	
140	<p>Read the value of the diameter indicated on the rim or tyre. The value of the diameter can be in inches or millimetres according to the selected unit of measure.</p>	
150	<p>Enter the reading by pressing [1] or [3] on the keyboard</p> 	
160	<p>Lower the wheel guard: the machine will run a launch.</p>	

170	<p><b>By hand, turn</b> the wheel in the direction marked by the arrow until you see 50 g on the left display.</p>	
180	<p>On the inner side of the wheel, at 12 o'clock, apply the 50 g weight.</p>	
190	<p>Lower the wheel guard: the machine will run a launch.</p>	
200	<p>Remove the 50 gr. weight applied on the internal side. <b>By hand, turn</b> the wheel in the direction marked by the arrow until you see 50 g on the right display.</p>	
210	<p>On the outer side of the wheel, at 12 o'clock, apply the 50 g weight.</p>	
220	<p>Lower the wheel guard: the machine will run a launch.</p>	
230	<p><b>If the balancing machine is equipped with the electromagnetic brake for positioning, at the end of the previous spin the machine will perform a set of short spins to calibrate the function of automatic stop on imbalance position</b> (see chapter <i>SWI Stop the wheel on imbalance</i>). <b>Do not lift the wheel guard and do not press [9] key during this procedure.</b></p>	
240	<p>Calibration is finished: the machine automatically exits the calibration program and returns to the NORMAL mode, ready to perform the balancing.</p>	



At any time it is possible to exit the calibration procedure by pressing [5] key.

### 13.2 Machine calibration for the MOTO wheel type

The calibration for MOTO wheel type (motorcycle wheels) is completely separated from CAR/SUV wheel type because in the calibration for MOTO a specific adaptor for motorcycle wheels is used

If the calibration for MOTO wheel type has not been done and the user try to spin the wheel for balancing in the MOTO wheel type mode, the machine will not run and will display an error code **ERR 031**.

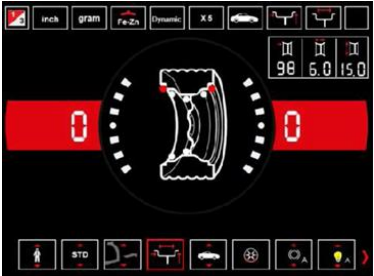
To perform the machine calibration with adaptor for motorcycle wheels, proceed as follows:

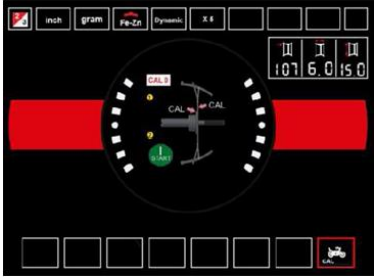
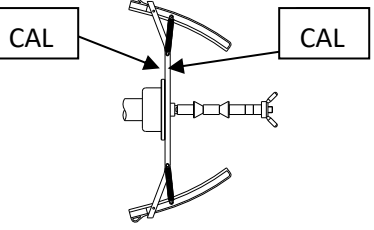
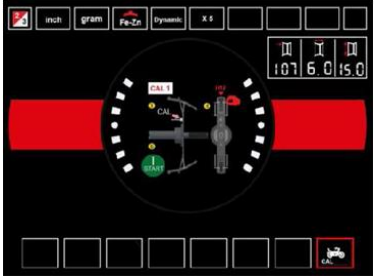
Op.	Description	
10	<p>Press [2] or [4] from the keyboard  and select the icon relative to the programme to be used.</p>	
20	<p>Activate the MOTO calibration programme by selecting  CAL which will turn green.</p>	
30	<p>Confirm activation of the MOTO calibration programme by pressing [6] on the keyboard.</p>	
40	<p>Mount the motorcycle adaptor on the shaft as shown here.</p>	
50	<p>Lower the wheel guard: the machine will run a launch.</p>	
60	<p>At the end of the launch, the machine will display the message shown here. Apply the calibration weight to the inner side, as shown. The calibration weight must be applied on the hole marked with the "CAL" inscription.</p>	
70	<p>Lower the wheel guard: the machine will run a launch.</p>	

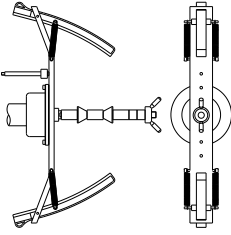
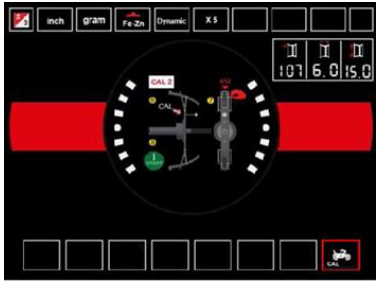
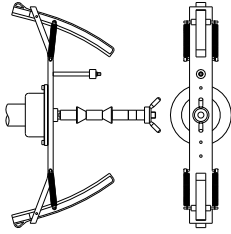
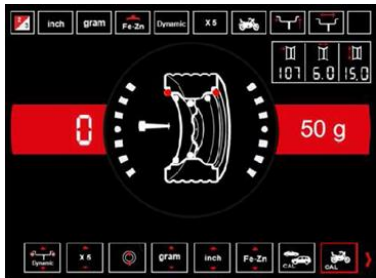
80	Move the motorcycle adaptor to a stable <u>vertical position</u> with the calibration weight at the top as shown in the figure. <i>If the weight position is significantly different from the vertical position, the machine will refuse to perform the spin and it will display an error code <b>ERR 043</b>. If the motorcycle adaptor is near to the vertical position but not in the precise vertical position, the machine will spin but at the end of the calibration each balancing spin will have an error in the balancing angular position of the weights.</i>	
90	Lower the wheel guard: the machine will run a launch.	
100	At the end of the launch, the machine will display the message shown here. Apply the calibration weight to the outer side as seen here. The calibration weight must be applied on the hole marked with the "CAL" inscription.	
110	Move the motorcycle adaptor to a stable vertical position with the calibration weight at the top as shown in the figure. <i>If the weight position is significantly different from the vertical position, the machine will refuse to perform the spin and it will display an error code <b>ERR 043</b>.</i>	
120	Lower the wheel guard: the machine will run a launch.	
130	At the end of the spin, the MOTO wheel type calibration is finished and the machine will switch to NORMAL mode, ready to run the balancing.	

When the calibration is finished the MOTO wheel type and ALU1 Program Type value are set. Also the wheel data are automatically set by machine for this type of calibration.

At any time it is always possible to exit the calibration procedure during its progress by pressing the [5] key. The MOTO wheel type and the ALU1 Program Type will remain set. The wheel dimensions will be those which were automatically set by the machine for this kind of calibration.

#### 14. USE OF THE MACHINE IN NORMAL MODE

The machine allows the choice between eight different Program Type of balancing as listed in table T14.1.

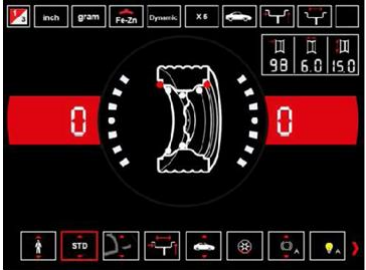



**Table T14.1: Program Types available**

Program Type	Wheel material	Weight position along the rim selection	Automatic acquisition <sup>(1)</sup>	Notes
STD	Steel	Default	2 sensors	Default at power on
ALU1	Aluminium	Default	2 sensors	Forcibly set when the Motorbike Program Type is selected
ALU2	Aluminium	Default	2 sensors	
ALU3	Aluminium	Default	2 sensors	

ALU4	Aluminium	Default	2 sensors	
ALU5	Aluminium	Default	2 sensors	
ALS1	Aluminium	Default inner weight, outer weight provided by user	1 sensor	
ALS2	Aluminium	Provided by user	1 sensor	

**14.1 Type of program (Program Type)**

To select the programs in NORMAL mode proceed as follows:

Op.	Description	
10	<p>Press [2] or [4] from the keyboard  and select the icon relative to the programme to be used.</p>	
20	<p>Activate the STANDARD programme by selecting  (by default at start-up) which will turn green.</p> <p>Scroll through the list of available programmes by pressing [1] or [3] on the keyboard.</p> <p></p>	

The position of the balancing weights along the section of the rim in the various Program Types is shown in picture F14.1.

**Picture F14.1: Position of the weights in the various Program Types along the section of the rim**

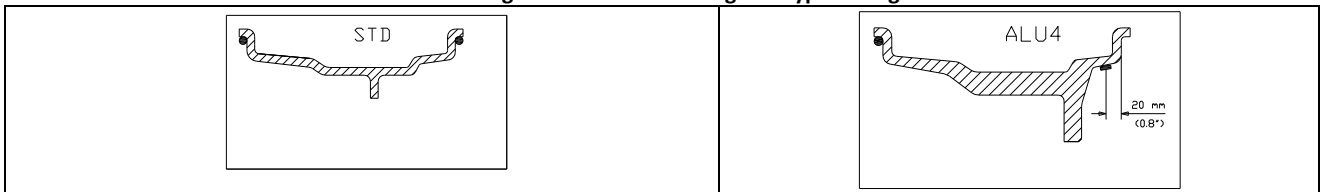

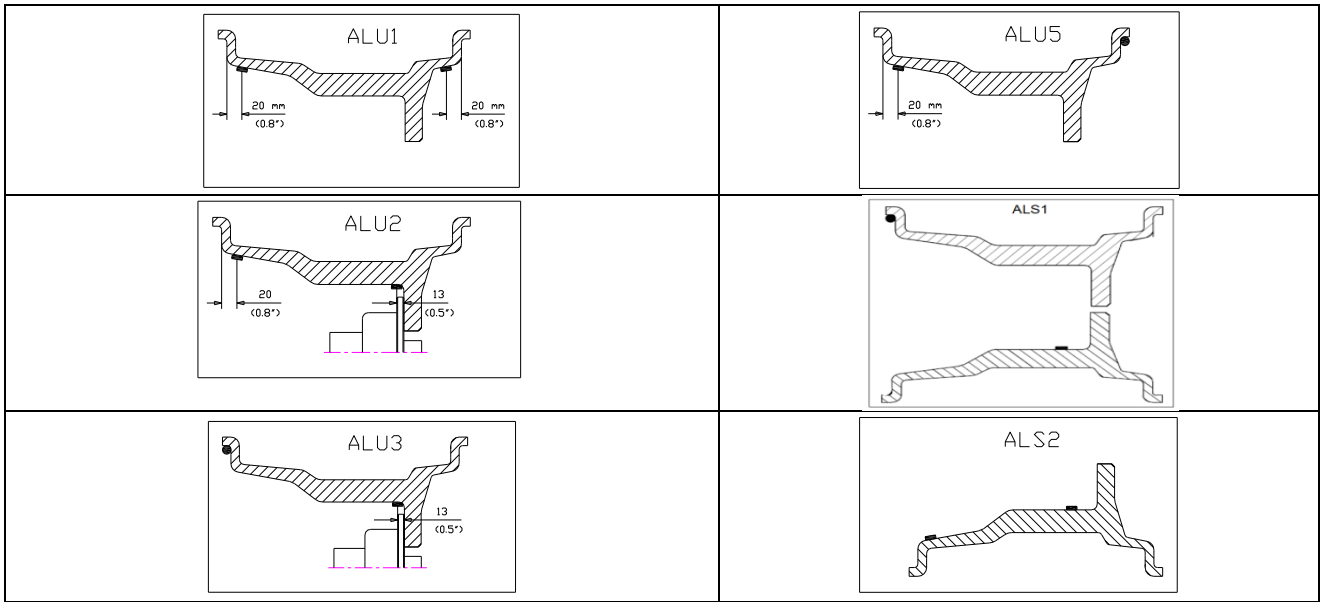

Angular position of the balancing weights in the several Program Type is shown in table T14.2.

**Table T14.2: Angular position of the balancing weights in the various Program Types**

Machine data acquisition system	Program Type								
	STD, ALU1,2,3,4,5			ALS1			ALS2		
	Internal plane	External plane	Static plane	Internal plane	External plane	Static plane	Internal plane	External plane	Static plane
Semi-automatic	H12	H12	H12	H12	Sensor-rim contact point <sup>(1)</sup>	H6	Sensor-rim contact point <sup>(1)</sup>	Sensor-rim contact point <sup>(1)</sup>	H6
Automatic	H12	H12	H12	H12	Sensor-rim contact point <sup>(1)</sup>	H6	Sensor-rim contact point <sup>(1)</sup>	Sensor-rim contact point <sup>(1)</sup>	H6
Laser	H12	H12	H12	H12	H6 Sticker	H6	H6 Sticker	H6 Sticker	H6

Note (1): if the data acquisition system is disabled, the angular position of the weight will be in the 6 o'clock position.

In table T15.2 the symbol "H12" indicates that the angular position of the weight is at 12 o'clock while the symbol "H6" indicates that the angular position of the weight is at 6 o'clock.

\*\*\*There's laser device in main shaft cover on the machine with three values automatic inputting function. When the laser function is on, under the ALUS mode, the laser will light automatically at the unbalance position. At this moment, stick the weight at the 6 o'clock position on the rim. \*\*\*

The machine data acquisition systems are defined as follows:



- Semi-automatic when the Distance and Diameter data are automatically acquired with the Distance/Diameter sensor while the data on the width must be manually entered;
- Automatic when all data of the rim is automatically acquired with the two sensors.

#### 14.2 Wheel types







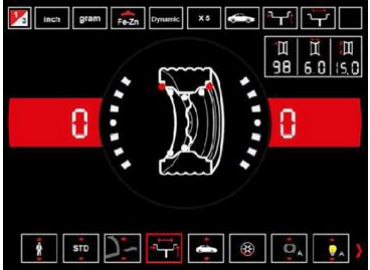

The machine allows choosing between three different Wheel Types as listed in table T14.3.

**Table T14.3: Wheel Types to select**

Wheel Type	Vehicle	Notes
------------	---------	-------

CAR 	Auto-vehicles	Default power on
MOTO 	Motorbikes	Forcibly set the ALU1 Program Type
SUV 	Off-Road vehicles	Not suitable for balancing truck wheels

To select a specific wheel type, proceed as follows:





Op.	Description	
10	<p>Press [2] or [4] from the keyboard  and select the icon relative to the programme to be used.</p>	
20	<p>Activate the AUTO programme by selecting  (by default at start-up) which will turn green.</p>	
30	<p>Scroll through the list of available programmes by pressing [1] or [3] on the keyboard  and activate the MOTO programme by selecting .</p>	
40	<p>Scroll through the list of available programmes by pressing [1] or [3] on the keyboard  and activate the SUV programme by selecting .</p>	

**14.2.1 CAR wheel type**

The selection of the CAR Wheel Type allows the balancing of wheels of auto-vehicles.

To select the CAR wheel type, proceed as follows:

Op.	Description	
-----	-------------	--









10	<p>Press [2] or [4] from the keyboard  and select the icon relative to the programme to be used.</p>	
20	<p>Activate the AUTO programme by selecting  (by default at start-up) which will turn green. Ensure that the status icon  is activated.</p>	

### 14.2.2 MOTO wheel type

The selection of MOTO wheel type allows the balancing for the motorbike wheels.

These wheels must be fit on the shaft by using a specific motorcycle wheel adaptor. Since the motorcycle adaptor keeps farther the wheel from the machine, it is necessary to install an appropriate extension for the diameter gauge.

To select the MOTO wheel type, proceed as follows:

Op.	Description	
10	<p>Press [2] or [4] from the keyboard  and select the icon relative to the programme to be used.</p>	
20	<p>Activate the AUTO programme by selecting  (by default at start-up) which will turn green.</p>	
30	<p>Scroll through the list of available programmes by pressing [1] or [3] on the keyboard  and activate the MOTO programme by selecting . Ensure that the status icon  is activated.</p>	

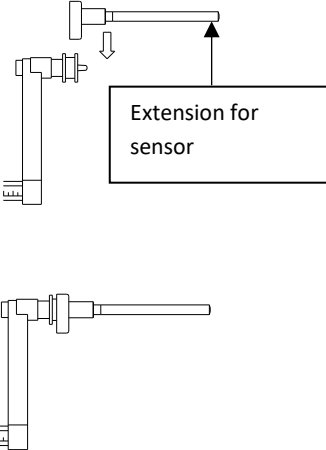
40	<p>To acquire automatically the geometrical wheel data by Distance/Diameter and Width sensors, it is necessary to keep the same reference points on the rim as Program Type ALU1.</p> <p>Furthermore, when the Wheel Type MOTO is selected, the actual distance value is increased of 150 mm due to the extension length for the Diameter/Distance sensor.</p>	
----	--	---

When the Wheel Type MOTO is activated, automatically, the ALU1 Program Type is selected, if you attempt to select another programs by keys [2] o [4] the machine will display the error code **ERR 043**.

To acquire automatically the geometrical wheel data by Distance/Diameter and Width sensors, it is necessary to keep the same reference points on the rim as Program Type ALU1.

Furthermore, when the Wheel Type MOTO is selected, the actual distance value is increased of 150 mm due to the extension length for the Diameter/Distance sensor.







Each time the motorcycle adaptor is removed (for example for balancing a car wheel) and installed again, it is always necessary to match the written "Cal" which are present on the flange and on the motorcycle adaptor otherwise the balancing accuracy may be compromised.

### 14.2.3 OFF ROAD wheel type

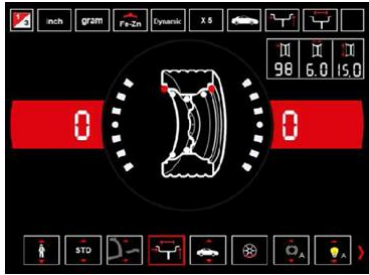
The selection of SUV wheel type allows the balancing of wheels for off-road vehicles. These vehicles are generally equipped with wheels that are larger than normal and the tyre is relatively large compared to the diameter of the rim (that means not the low profile or super low profile types). The selection for this wheel type doesn't allow to balance the truck wheels, because the profiles for those rims are considerably different.

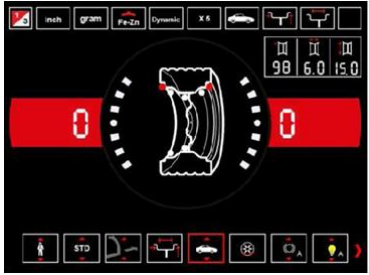
To select the SUV wheel type, proceed as follows:

Op.	Description	
-----	-------------	--

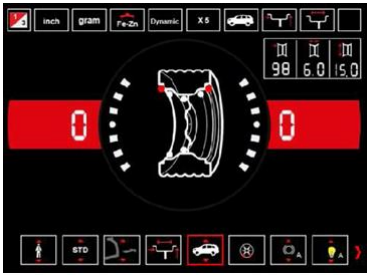
10	<p>Press [2] or [4] from the keyboard  and select the icon relative to the programme to be used.</p>	
20	<p>Activate the AUTO programme by selecting  (by default at start-up) which will turn green.</p>	
30	<p>Scroll through the list of available programmes by pressing [1] or [3] on the keyboard  and activate the programme and activate the SUV programme by selecting . Ensure that the status icon  is activated.</p>	

For SUV wheel type all Programs Type listed in table T14.1 are available. The weights position to be applied on the rim section are the same as those shown in picture F14.1.









### 14.3 Entering wheel dimensions

The dimensions of the wheel to balance can be entered in automatic way (partially or completely).

#### 14.3.1 Automatic acquisition of the wheel dimensions for the STD and ALU1, 2, 3, 4, 5 Program Types

To automatically introduce the wheel size data, proceed as follows:

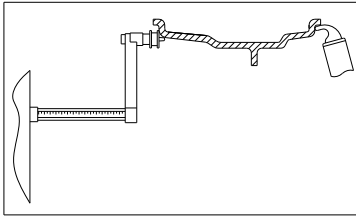







Op.	Description	
-----	-------------	--

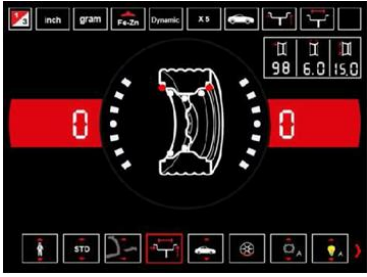

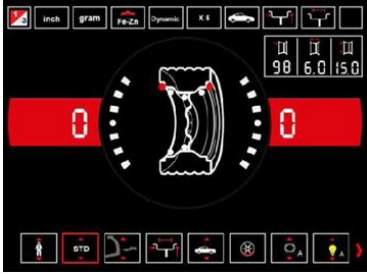
10	Fit the wheel on the shaft and tighten with the ring nut.	
20	 <p>Press [2] or [4] from the keyboard and select the icon relative to the programme to be used.</p>	
30	<p>Activate the STANDARD programme by selecting  (by default at start-up) which will be outlined in green.</p> <p>Scroll through the list of available programmes by pressing [1] or [3] on the keyboard.</p> 	
40	Select the icon relative to the required programme.	
50	Only for programmes STD, ALU1, ALU2, ALU3, ALU 4, ALU5; take out both sensors and place them on the rim, as shown here.	
60	Wait to hear the long acquisition beep and then set the sensors back to the rest position. During acquisition the distance and diameter values are displayed on the wheel dimension data band.	

### 14.3.2 Automatic acquisition of the wheel dimensions for the ALS1, ALS2 program types

To automatically enter the dimensions of the wheel in the ALS1 and ALS2 program types proceed as follows:

Op.	Description	
10	Fit the wheel on the shaft and tighten with the ring nut.	

20	 <p>Press [2] or [4] from the keyboard and select the icon relative to the programme to be used.</p>	
30	<p>Activate the STANDARD programme by selecting  (by default at start-up) which will be outlined in green.</p> <p>Scroll through the list of available programmes by pressing [1] or [3] on the keyboard.</p> 	
40	<p>Activate the ALS programme by selecting  or .</p>	
50	<p>Extract the Distance/Diameter sensor and place it on the plane chosen as the internal plane. The position is different depending on the programs selected ALS1 or ALS2.</p> <p>ALS1: The white weight represents the internal weight on the clip. See figure here.</p> <p>ALS2: The blue weight represents the adhesive internal weight. See figure here.</p>	<p><b>Automatic acquisition of the internal plane distance and diameter in ALS1 Program Type</b></p>  <p><b>Automatic acquisition of the internal plane distance and diameter in ALS2 Program Type</b></p> 
60	<p>Wait to hear the long acquisition beep and then set the Distance/Diameter sensor back to the rest position. During acquisition the distance and diameter values are displayed on the wheel dimension data band. <i>Acquisition of the internal plane is confirmed by a long beep followed by a short beep.</i></p>	

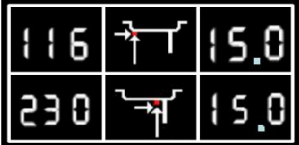
70	Extract the Distance/Diameter sensor and place it on the plane chosen as the external plane. The red weight represents the adhesive external weight. See figures here.	<p><b>Automatic acquisition of the internal plane distance and diameter in ALS1 Program Type</b></p>  <p><b>Automatic acquisition of the internal plane distance and diameter in ALS2 Program Type</b></p> 
80	Wait to hear the long acquisition beep and then set the sensor back to the rest position. <i>Acquisition of the external plane is confirmed by a long beep followed by two short beeps.</i>	
90	The wheel dimensions have been acquired and the values can be displayed on the wheel dimensions data band.	

#### 14.4 Use of the special program types for ALS1 and ALS2 aluminum wheels

The machine has two special Program Types for aluminum wheels called ALS1 and ALS2.

When under the STD mode, pull the scale twice continuously, can enter the ALS2 mode directly.

These two programs are different from standard Program Type for aluminum wheels (ALU1 up to ALU5) because the user is allowed to select the position where to apply the weights. This allows to balance the aluminum wheels having particular shapes, difficult to perform with standard program where the weight are applied in precise positions. The difference between ALS1 and ALS2 program is that in ALS1 Program Type the user could select freely the outer balancing positions (inner position) instead in ALS2 Program Type the user could select freely both of balancing positions.

The ALS1 or ALS2 program types use only the Distance/Diameter sensor to acquire the balancing planes chosen by the user. The width sensor is not used.

The use of the ALS1 or ALS2 program types is divided into three parts:

- Acquisition of balancing planes (See paragraph 14.3.2);
- Balancing spin;
- Search of the balancing planes for weight application.

##### 14.4.1 Balancing spin



To perform the balancing spin, proceed as follows:

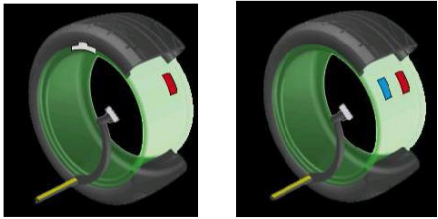

Op.	Description	
-----	-------------	--

10	Lower the wheel guard to run the balancing launch. Once the spin cycle is completed, the imbalance values calculated, according to the balancing planes chosen, will be displayed.	
20	The machine also automatically sets the Search mode of the balancing planes.	 <p style="text-align: center;">ALS1                      ALS2</p>

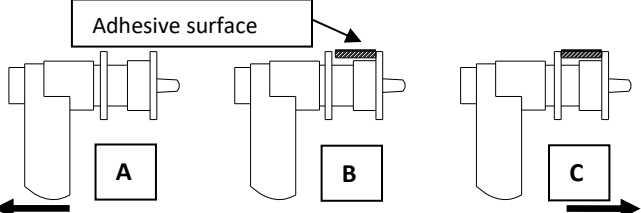

#### 14.4.2 Search of the balancing planes

The purpose of the balancing planes research is to find the balancing planes which were previously selected by the operator in order to apply the balancing weights. Proceed as follows:

Op.	Description	
10	Apply the weight shown on the left display (internal position) on top of the Distance/Diameter sensor gauge as shown here.	
20	Manually rotate the wheel until all the internal imbalance position leds light up (see figure here). Block the wheel in this position with the help of the pedal brake (if installed) or the electromagnetic brake.	
30	Slowly extract the sensor until you hear the continuous beep indicating that the internal balancing plane has been reached. The blue band represents the application point of the internal weight.	
40	Block the Distance/Diameter sensor at this distance, then, rotate it until the adhesive weight sticks on the rim. The sensor contact point will be a midway position between 12 o'clock and 6 o'clock, depending on the rim diameter.	

50	Release the wheel and turn it by hand until all of the external imbalance position leds light up. Slowly extract the sensor until you hear the continuous beep indicating that the external balancing plane has been reached. The red band represents the application point of the external weight.	
60	Block the Distance/Diameter sensor at this distance, then, rotate it until the adhesive weight sticks on the rim. The sensor contact point will be a midway position between 12 o'clock and 6 o'clock, depending on the rim diameter.	
70	Lower the wheel guard to run the balancing launch. At the end of the launch, the imbalance data will be displayed.	
80	If you have to balance an identical wheel, it is possible to skip the data acquisition of the balancing planes and perform immediately with the balancing spin and then with the search for balancing planes. The balancing planes used for the calculation will be the same as stored before by the machine.	

When the laser function is on:



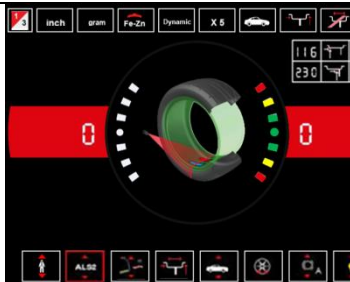

Op.	Description	
10	The unbalance weight will be displayed when the rotation stops.	
20	Rotate the tire till all the left (or right) leds light.	
30	Then stick the weight to the inner side at 6 o'clock position.	



40	Rotate the tire till all the right (or left) leds light.	
50	Then stick the weight to the outer side at 6 o'clock position.	
60	Pull down the protection cover to start rotation. The unbalance weight will be displayed after rotation.	
70	If balance the same size tire, can skip the data acquirement step and rotate the tire to balance directly then search the unbalance position. The balance data for calculation is the same as the last data which the machine stored.	

### 15. OPTIMIZATION

The optimization program is used to minimize the amount of balancing weights to be applied on the rim by opposing the imbalance of the rim to that of the tyre. Therefore, use this program when the wheel requires the application of heavy balancing weights.

To enter in OPTIMIZATION Program proceed as follows:

Op.	Description	
10	Lower the wheel guard: the machine will run a launch.	
20	Press [2] or [4] from the keyboard  and select the icon relative to the programme to be used.	
30	Activate the OPTIMISATION programme by selecting  (which will be outlined in green) and confirm by pressing [6] on the keyboard.	
40	If the wheel's static imbalance is less than 12 grams, the <b>ERR 055</b> error message will appear and it will automatically exit the optimisation programme. If, on the other hand the wheel's static imbalance is greater than 12 grams, the machine will start the OPTIMISATION programme.	

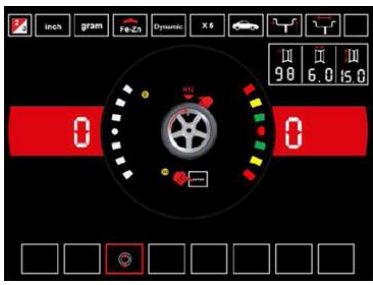
50	Position the valve at 12 o'clock, make a mark on the tyre where the valve is and press [6] on the keyboard.	
60	Remove the wheel from the shaft, remove the tyre bead, rotate it so that the mark is at 180° with respect to the valve.  Re-install the wheel on the shaft, and erase the mark made previously.  Lower the wheel guard: the machine will run a launch.	
70	At the end of the launch, place the valve at 12 o'clock and press [6] on the keyboard to continue. In this case the message seen in the figure for the next phase will appear.	
80	Rotate the wheel until all position arrow LEDs light up and then mark the 12 o'clock position and press key [6] on the keyboard.	
90	Remove the wheel from the balancing machine, remove the bead from the tyre and rotate it until the valve matches the mark on the tyre. Optimisation is finished: exit the optimisation menu by pressing [5].	
100	Remount the wheel on the balancing machine and balance it with the normal procedure.	

## 16. HIDDEN WEIGHTS PROGRAM

This program divides the external weight "Pe" in two weights W1 and W2 (smaller than the initial external weight W) located in any two positions selected by the operator.

The two weights W1 and W2 must form a maximum angle of 120° including the external weight "Pe", as shown in picture F16.1.

**Picture F16.1: Hidden Weights Program: valid and invalid conditions for use in this example the balancing external weight  $P_e$  is indicated at 12 o'clock (H12) but can be at 6 o'clock (H6) or at 3 o'clock (H3): see text**

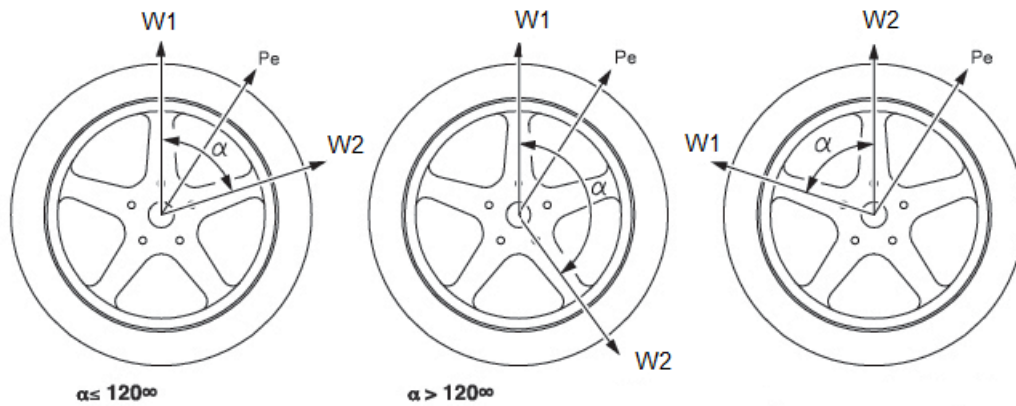







The Hidden Weights program is used for aluminum rims when:

- You want to hide the external weight behind two spokes for aesthetic reasons;
- The position of the external weights coincides with a spoke therefore a single weight cannot be applied.

*NOTE: This program can be used with any Program Type and with any Wheel Type. It can also be used to divide the static weight into two separate weights (especially useful with wheels for motorbikes).*

To enter in HIDDEN WEIGHTS Program, proceed as follows:

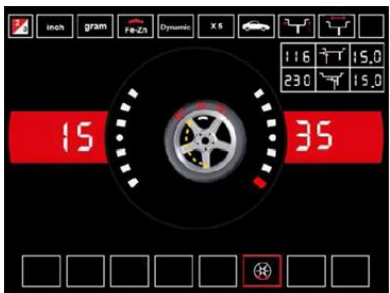
Op.	Description	Display
10	Apply the internal weight, stated on the left display, on the rim.	
20	Turn the wheel by hand until all of the external imbalance search LEDs light up.	
30	 <p>Press [2] or [4] from the keyboard and select the icon relative to the programme to be used.</p>	

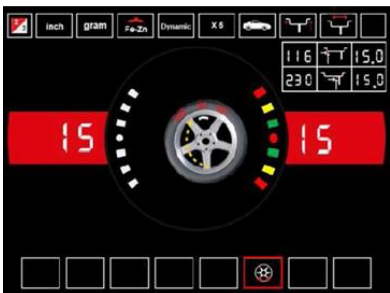
40	<p>Activate the HIDDEN WEIGHTS programme by selecting  (which will be outlined in green) and confirm by pressing [6] on the keyboard.</p> <p>If the wheel is balanced on the external side, the machine will display error code <b>ERR 050</b> to signal that the operation is not allowed.</p>	
50	<p>Manually rotate the wheel anticlockwise and with the sensor behind the first selected spoke. Confirm by pressing [6] on the keyboard.</p>	
60	<p>Manually rotate the wheel anticlockwise passing the imbalance point and with the sensor behind the second selected spoke.</p> <p>Confirm by pressing [6] on the keyboard.</p>	
70	<p>Using the sensor gauge head, apply the weight behind the first selected spoke W1.</p>	
80	<p>Using the sensor gauge head, apply the weight behind the second selected spoke W2.</p>	
90	<p>The procedure of the Hidden Weights programme is finished: press [5] to exit and launch the balancing test.</p>	

## 17. SECOND OPERATOR

The machine has two separate memories allowing two operators to work simultaneously with different settings.







This feature can make operations at the workshop quicker because when, for example, an operator is busy with removing or remounting a tyre, the other operator can use the machine to perform balancing operations and vice versa.

In this manual, the two operators are defined as *operator 1* and *operator 2*.

When operator 1 has completed his tasks on the machine or is involved in other activities, operator 2 can work with the machine using the settings for the wheel type he is working on without altering the settings entered by operator 1.

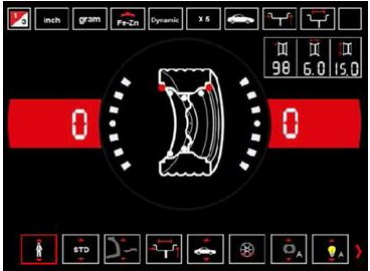
When the machine is switched on, the two memories are set with the same values by default.

To select the SECON OPERATOR Program, proceed as follows:

Op.	Description	
10	Press [2] or [4] from the keyboard  and select the icon relative to the programme to be used.	
20	Activate the program for 1 OPERATOR by selecting  (by default at start-up) which will turn green.	
30	Scroll through the list of available programs by pressing [1] or [3] on  .	
40	Activate the program for 2 OPERATORS by selecting  .	

## 18. UTILITY PROGRAMS

Utility programs are available only in NORMAL mode.







### 18.1 Selecting the imbalance display resolution

The machine has two wheel imbalance display resolutions. The two resolutions are defined as X1 (high resolution) and X5 (low resolution). The resolution with which the imbalances of the wheel are displayed varies depending on the unit of weight as indicated in table T18.1.

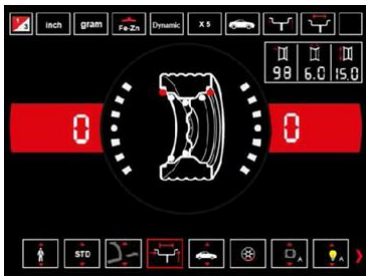
**Table T18.1: Display resolution**

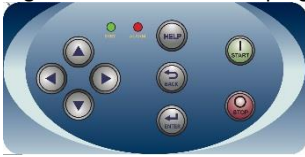

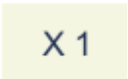



Set resolution	Imbalance unit of measurement	Display resolution	Notes
X1 (High resolution)	Grams	1 gram	The X5 resolution is set by default at start-up
	Ounces	0.1 ounces	
X5 (Low resolution)	Grams	5 grams	
	Ounces	0.25 ounces	

To modify the IMBALANCE DISPLAY RESOLUTION, proceed as follows:

Op.	Description	
10	<p>Press [2] or [4] from the keyboard  and select the icon relative to the programme to be used.</p>	
20	<p>Activate the WORK RESOLUTION programme by selecting  (by default at start-up) which will turn green.</p>	
30	<p>Scroll through the list of available programmes by pressing [1] or [3] on the keyboard .</p>	
40	<p>Activate the "X1" RESOLUTION programme by selecting .</p> <p>Ensure that the status icon  is activated.</p>	

## 18.2 Selection of the static imbalance display

To display STATIC IMBALANCE proceed as follows:

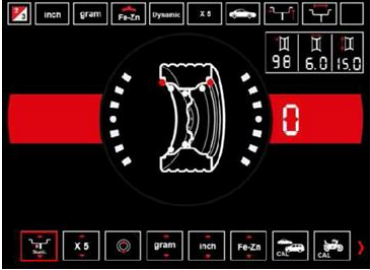
Op.	Description	Display
10	<p>Press [2] or [4] from the keyboard  and select the icon relative to the programme to be used.</p>	
20	<p>Activate the DYNAMIC programme by selecting  (by default at start-up) which will turn green.</p>	
30	<p>Scroll through the list of available programmes by pressing [1] or [3] on the keyboard .</p>	
40	<p>Activate the STATIC programme by selecting  . Ensure that the status icon  is activated.</p>	





*Note: in some cases, static imbalance is forcibly set by the machine according to the current settings. For example, if the MOTO Wheel Type program is enabled and the width set is less than 4.5 inches, the machine will automatically set the static imbalance display.*

### 18.3 Electromagnetic clamping brake

The electromagnetic clamping brake is useful to block the wheel in any position and to simplify some operations such as the application or removal of balancing weights.

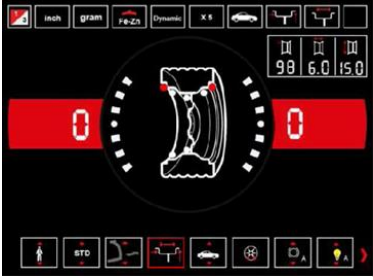
The electromagnetic clamping brake is also used in the automatic or manual stopping of the wheel on imbalance positions described in chapter 18.5 *Wheel stop procedure on the positions of imbalance*.

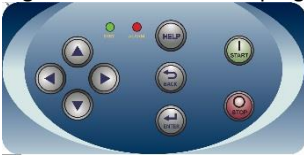
To activate and/or deactivate the ELECTROMAGNETIC BRAKE proceed as follows:

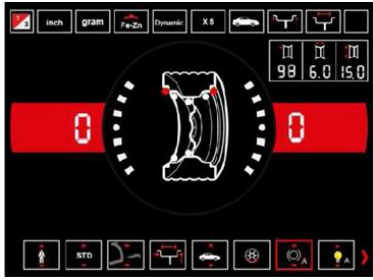
Op.	Description	
10	Press [2] or [4] from the keyboard  and select the icon relative to the programme to be used.	
20	Activate the BRAKE ENABLING programme by selecting  (by default at start-up) which will turn green.	
30	Scroll through the list of available programmes by pressing [1] or [3] on the keyboard  .	
40	Activate BRAKE DISABLING by selecting  .	

The electromagnetic clamping brake is deactivated automatically in the following cases:







- Every time a balancing launch is run;
- Every time a wheel stop procedure is performed (stop of the wheel on the imbalance position) at low speed;
- After one minute of continuous activation (to avoid overheating of the brake itself).

The electromagnetic clamping brake can be used manually only in NORMAL mode. It cannot be used in the SERVICE mode.

### 18.4 Illuminator

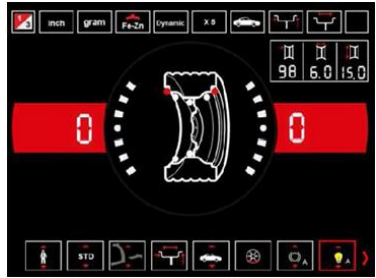
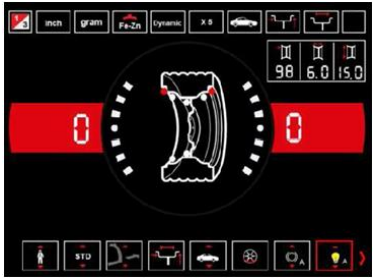
The illuminator is quite useful because it allows shedding light on the internal part of the rim.

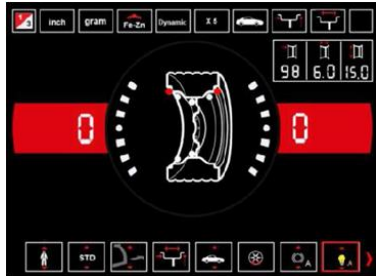
To activate and/or deactivate the ILLUMINATOR proceed as follows:

Op.	Description	Display
10	 <p>Press [2] or [4] from the keyboard and select the icon relative to the programme to be used.</p>	
20	 <p>Activate the ILLUMINATOR ENABLING programme by selecting  (by default at start-up) which will turn green.</p>	
30	 <p>Scroll through the list of available programmes by pressing [1] or [3] on the keyboard.</p>	
40	 <p>Activate the ILLUMINATOR DISABLING programme by selecting .</p>	

The illuminator is also automatically managed by the machine that turns it on in the following cases:











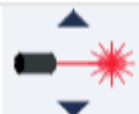

- When the Distance/Diameter sensor is extracted;
- After a wheel stop procedure on the position of imbalance (wheel stop procedure) which resulted in the balancing position of the internal weight;
- When the wheel itself is in the balancing position of the internal weight by manually rotating the wheel after a launch.

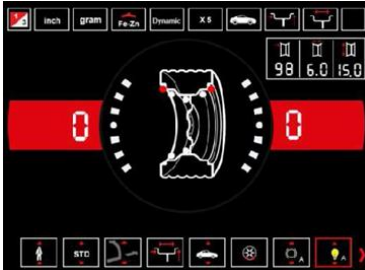
### 18.5 laser

The function of laser is to positioning the final imbalance point in order to facilitate the operator to observe and operate.

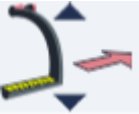
To activate and/or deactivate the laser proceed as follows: (only display under ALUS2 mode)

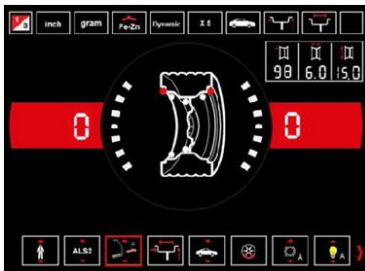
Op.	Description	Display
-----	-------------	---------

10	 <p>Press [2] or [4] from the keyboard and select the icon relative to the program to be used.</p>	
20	<p>Activate the laser program by selecting . The icon will become . The laser is activated.</p>	
30	<p>Scroll through the list of available program by pressing [Back], [2] or [4] on the  keyboard.</p>	
40	<p>Activate the ALS2 mode by selecting . The icon  is activated.</p>	
50	<p>Select  and the icon  is activated.</p>	
60	<p>Finally the laser display interface appears. Laser function is activate.</p>	

### 18.6 Wheel stop procedure on the positions of imbalance

Machines equipped with the electromagnetic clamping brake are capable of automatically stopping the wheel at the first imbalance angular position that is reached during rotation. This allows the operator to have the wheel in position ready for the application of the balancing weight thus increasing work and productivity speeds.

**Table T18.2: Types of wheel stop procedures available**

SWI mode	When it is or when it can be run	Who can run the procedure	Notes
Automatic	At the end of every launch.	Machine	This is performed only if there is at least one imbalance value on the wheel. Otherwise, conventional braking will occur.
Low speed	At the end of the launch, when the wheel is stationary and the wheel guard is raised.	Operator	Procedure started by pressing [8] key Start: the wheel starts spinning at low speed until the first angular position of imbalance is reached.
Manual	At the end of the launch by manually rotating the wheel with wheel guard raised.	Operator	At each passage of the wheel in an angular position of imbalance, the electromagnetic clamping brake will be enabled for 30 seconds.

#### 18.6.1 Automatic wheel stop procedure

During the automatic wheel stop procedure, the machine will measure rotational speed during braking at completion of the launch and, when this reaches a predetermined value, it will release the brake allowing the wheel to spin freely by inertia. When the speed is low enough, the machine will wait until the wheel passes through one of the angular positions of imbalance, therefore, it will enable the electromagnetic clamping brake.

---

*Note: for operator safety purposes, the wheel stop procedure will not be run when the MOTO Wheel Type is enabled.*

---

#### 18.6.2 Wheel stop procedure at low speed

In the low speed wheel stop procedure, the wheel has already run the launch and is stationary. If the operator presses [8] key Start with the wheel guard raised, the machine will apply slight acceleration to the wheel and then let it spin by inertia. When the speed is low enough, the machine will wait until the wheel passes through one of the angular positions of imbalance, therefore, it will enable the electromagnetic clamping brake.

---

*Note: for operator safety purposes, the wheel stop procedure will not be run when the MOTO Wheel Type is enabled.*

---

#### 18.6.3 Manual wheel stop procedure









In this mode, the wheel stop procedure is activated by manual rotation of the wheel if the wheel guard is raised. When the wheel passes through an angular position of imbalance, the machine will enable the electromagnetic clamping brake.

Angular positioning accuracy depends on many factors. Among the most important, they are: wheel dimensions and weight, adjustment of the electromagnetic brake, temperature, belt tension. In all cases, consider the following:

- If the electromagnetic clamping brake is disabled, the wheel stop procedure will not be run in any of three modes;
- If rotation speed decreases abruptly due to wheel inertia during the automatic wheel stop procedure or the low speed wheel stop (e.g. due to excessive friction with rotating mechanical parts) the machine applies a little extra acceleration to the wheel itself in order to reach the first angular position of imbalance. If, despite this, the wheel does not reach this position, the wheel stop procedure is aborted after 5 seconds and the machine displays the error code **ERR 042**;
- When you use the manual wheel stop procedure, balancing precision will also depend on the speed with which the operator rotates the wheel: excessively high or low speeds reduce accuracy.



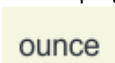



### 18.7 Select grams/ounces

To modify the current UNIT OF MEASUREMENT, proceed as follows:

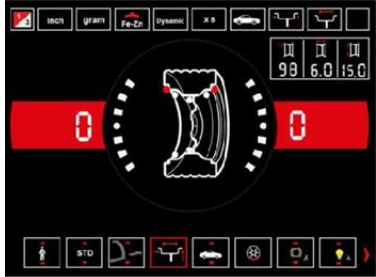
Op.	Description	
10	<p>Press [2] or [4] from the keyboard  and select the icon relative to the programme to be used.</p>	
20	<p>Activate the work programme in GRAMS by selecting  (by default at start-up) which will turn green.</p>	
30	<p>Scroll through the list of available programmes by pressing [1] or [3] on the  keyboard.</p>	
40	<p>Activate the work programme in OUNCES by selecting , ensure that status icon  is activated.</p>	

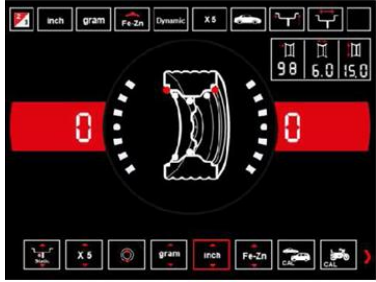
### 18.8 Select inches/millimeters

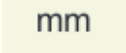
To modify the UNIT OF MEASUREMENT OF WHEEL DIMENSIONS, proceed as follows:

Op.	Description	
10	<p>Press [2] or [4] from the keyboard  and select the icon relative to the programme to be used.</p>	
20	<p>Activate the work programme IN INCHES by selecting  (by default at start-up) which will turn green.</p>	
30	<p>Scroll through the list of available programmes by pressing [1] or [3] on the  keyboard.</p>	
40	<p>Activate the work programme in MILLIMETRES by selecting , ensure that status icon  is activated.</p>	









### 18.9 Select balancing weights material Fe/Zn or Pb

The selection of the material type slightly changes the balancing results because the weights in Iron/Zinc are lighter than those in Lead and therefore are larger. The machine takes account of these differences when calculating the imbalance.

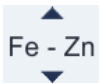
**Table T18.3: Balancing weights materials**

Option	Type of balancing weight material	Notes
Fe	Iron or Zinc	This material has been set by default.
Pb	Lead	In some countries (such as those of the European Community), Lead weights are prohibited by law.

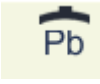
To modify the BALANCING WEIGHTS MATERIAL, proceed as follows:

Op.	Description	
10	<p>Press [2] or [4] from the keyboard  and select the icon relative to the programme to be used.</p>	
20	<p>Activate the work programme with WEIGHTS in IRON/ZINC by selecting  (by default at start-up) which will turn green.</p>	
30	<p>Scroll through the list of available programmes by pressing [1] or [3] on the keyboard .</p>	
40	<p>Activate the work programme in WEIGHTS IN LEAD by selecting , ensure that status icon  is activated.</p>	

## 19. ERROR CODES

The Error signal is always accompanied by a triple beep indicating that the machine cannot run the command given by the operator, or, during operation, conditions were encountered that prevent the action in progress from continuing.

The machine reports error conditions by displaying an outline of the description of the cause of the error. The list of error codes and description outlines is provided in table T19.1.

**Table T19.1: Error codes**

Error code	Description	Notes
000 to 009	Machine parameters internal error.	Contact technical support.
010	Reverse rotation of the wheel.	Contact technical support.
012	The wheel cannot be stopped at the end of the launch.	Check the mains voltage. If the checks do not lead to any results, contact technical support.
014	The wheel does not spin.	Contact technical support.
015	Keypad blocked at start-up.	Release all buttons, then turn off or restart the machine. If the error persists, contact technical support.
016	Distance sensor is not in rest position at start-up of the machine or when Start is pressed.	Place the sensor back in its rest position: the error should disappear. If the error persists, contact technical support. NOTE: if key [P5] is pressed the machine acquisition system is temporarily disabled and operation can be continued. The disabled status will last until the machine has been turned off.
017	Width sensor is not in rest position at start-up of the machine or when Start is pressed.	Place the sensor back in its rest position: the error should disappear. If the error persists, contact technical support. NOTE: if key [P5] is pressed the machine acquisition system is temporarily disabled and operation can be continued. The disabled status will last until the machine has been turned off.
019	Communication processor failure.	Turn the machine off and then on again. If the error persists, contact technical support. The machine can still be used but all functions related to the USB port are disabled.
020	Lack of communication with the eeprom memory.	Turn the machine off and then on again. If the error persists, contact technical support.
021	Lack of machine calibration data or incorrect calibration data.	Carry out calibration for the CAR/SUV Wheel Type and/or for the MOTO Wheel Type. If the error persists, contact technical support. See also ERR 030 and ERR 031.
022 to 024	Error during calibration.	Excessive imbalance or anomaly. Turn the machine off and then on again. If the error persists, contact technical support.
025	Presence of weight during the Cal0 calibration phase.	Remove the weight and repeat the launch of the Cal0 phase. If the error persists, contact technical support.
026	A launch without weight or failure of the pick-up A signal in the Cal2 calibration phase.	Apply the intended weight and repeat the launch. If the error persists, contact technical support.
027	A launch without weight or failure of the pick-up B signal in the Cal2 calibration phase.	Apply the intended weight and repeat the launch. If the error persists, contact technical support.
028	Launch with weight on the internal side during the Cal3 calibration phase. In this phase, the weight must be on the external side.	Remove the weight from the internal side and repeat the launch. If the error persists, contact technical support.
030	Lack of calibration data for the CAR/SUV Wheel Type.	Carry out calibration for the CAR/SUV Wheel Type.
031	Lack of calibration data for the MOTO (motorbike) Wheel Type.	Carry out machine calibration for the MOTO Wheel Type.
034	The MOTO Wheel Type is activated: a different Program Type other than ALU1 cannot be used.	Other Program Types cannot be selected.
039	The wheel guard is open: the requested action cannot be performed.	
043	The flange for motorbikes was not exactly vertical when Start was pressed during the MOTO Cal2 and Cal3 calibration phases.	Put the flange for motorbikes exactly vertical (and with the CAL reference on the upper part) then press [P8] Start. See chapter 16.3.
046	The Diameter sensor is enabled but disconnected.	Press key [P5]: the machine acquisition system is temporarily disabled and operation can be continued. The disabled status will last until the machine has been turned off.
047	The Width sensor is enabled but disconnected.	Press key [P5]: the machine acquisition system is temporarily disabled and operation can be continued. The disabled status will last until the machine has been turned off.
051	Hidden Weights program: the selected point is too far from the external imbalance position.	The point must be included up to 120° from the external imbalance position.
052	Hidden Weights program: the external imbalance position is not between the selected W1 and W2 points.	Choose W1 and W2 points so that they include the external imbalance position.
055	The static imbalance of the wheel is too low: the Optimization program cannot be used.	

(4) The error code can be exited in the following ways:

OPERATOR CONFIRMATION	The machine exits from the error code display when the operator presses any key.
OPERATOR ACTION	The machine exits from the error code display when the operator performs an action linked to said error code (for example, <b>ERR 016</b> brings the Distance sensor back to the rest position).
ONCE	The machines displays once the error code and its brief description, then it returns to the previous status.
PERMANENT	The machine permanently displays this error code until its turn-off, therefore the error code cannot be exited.

### 19.1 Acoustic signals

The machine emits different acoustic signals based on its status. The acoustic signals are listed in table T19.2.

**Table T19.2: Acoustic signals**

Signals	Meaning	Notes
Very brief beep	Manual entry of wheel geometric data.	
Short beep	Selecting a program or a function.	
Long beep	Acquisition.	<ul style="list-style-type: none"> <li>Acquisition of a value</li> <li>Acquisition of the wheel dimensions in the STD, ALU1, ALU2, ALU3, ALU4, ALU5 Program Types.</li> </ul>
Long beep + 1 Short beep		Acquisition of internal plane in ALS1 or ALS2 Program Types.
Long beep + 2 Short beep		Acquisition of external plane in ALS1 or ALS2 Program Types.
Double beep	Warning.	A particular condition has occurred that requires the operator's attention.
Triple beep	Function not available or Error.	The requested function is not available or an error condition has occurred.
Short Beep + Long beep	Storing one or more values in the permanent memory (eeprom) of the circuit board.	One or more values have been stored in the permanent memory of the circuit board (for example, at completion of calibration phases).
Intermittent beep	Adjustment.	Signal used in some service programs to simplify the adjustment of sensors.

The acoustic signal is also heard for about two seconds at machine start-up allowing the operator to check the operation of the alarm (buzzer).

### 20. FIRE PREVENTION MEANS TO USE

	Dry materials	Flammable liquids	Electrical equipment
Hydraulic	YES	NO	NO
Foam	YES	YES	NO
Powder	YES*	YES	YES
CO <sub>2</sub>	YES*	YES	YES

**YES\*:** Can be used in the absence of more appropriate means or for small fires.



The information in the table above is general and can be used as a rough guide. The responsibility for the use of each type of extinguisher must be obtained from the manufacturer.